

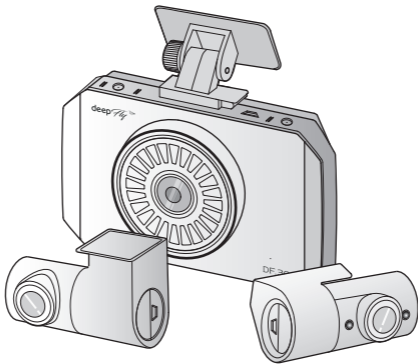

DEEPFLY DF30 **3CH**

QUICK GUIDE



Safety and Precaution

- Do not disassemble the product or subject the product to impact.
Doing so may damage the product.
Unauthorized disassembly of the product voids the product warranty.
- Do not operate the product while driving a vehicle.
Distraction while driving may cause accidents and result in injury or death.
- Do not expose the product to direct sunlight or intense light.
The lens or internal circuitry may fail permanent physical damages may result if it is operated or stored out of the specified temperature ranges.
Such damages are not covered by the warranty.
- Do not remove SD card or turn off the power cable during the firmware update.
It may cause malfunction or loss of data.
- Use of genuine DEEPLY memory card is recommended.
Failure to use genuine SD card may cause error or malfunction.
- Real-time recording and playback via Wi-Fi could be delayed depending on the specifications of your smart device.
- Motion detection is initiated by an image sensor software.
Errors may occur depending on the surrounding environment and the voltage of the car.
- If the GPS signal is good, ADAS will activate when the speed of the car is above the set speed. The surrounding environment may cause errors.
- Do not modify or cut the power cable. Also, do not place heavy objects on the power cable or pull, insert, or bend the power cable not using excessive force.
Doing so may result in electrical fire or electrocution.
- Unauthorized connection of the power cable may cause malfunctions.
Connections must be different depending on the power type of the vehicle.
(Please contact a professional engineer if you need help to install it)

INSTALL

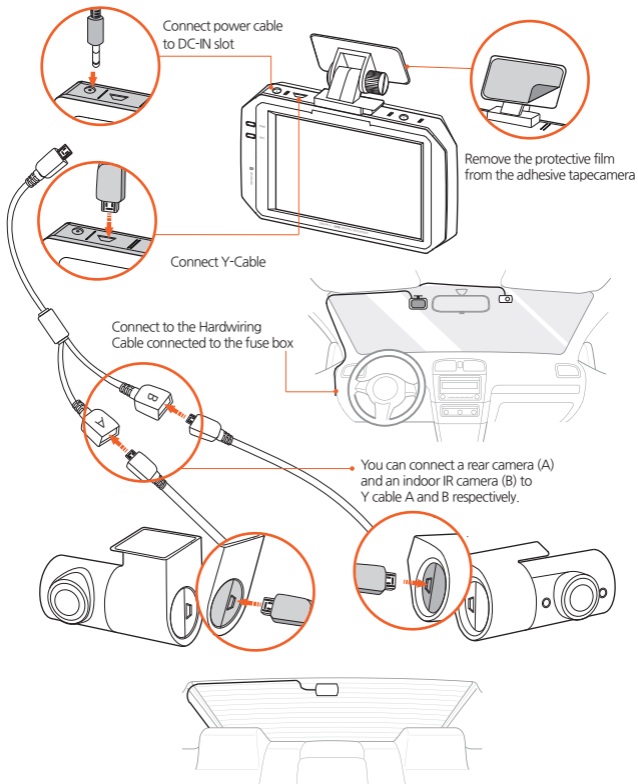

SPECIFICATIONS

SPECIFICATIONS

Product	Deepfly DF30	Camera	Front: 2.0M CMOS Sensor Rear: 2.0M CMOS Sensor IR(3Ch): 2.0M CMOS Sensor
Display Panel	3.5" Touch LCD (IPS)		Angle
Resolution Frame	Front: FHD 1080p, 30fps Rear: FHD 1080p, 30fps IR(3CH): FHD 1080p, 30fps	Video	H.264 / PCM
		Power	DC 12V ~ 24V
ADAS	LDWS / FVDW / FCWS	GPS	External GPS
Senear	3-Axis Accelerometer G-Sensor	Capacity	Micro SD 32GB-256GB
Audio	PCM(Pulse Code Modulation)	Temperature	Operation temp: -10° ~ 60°C
Wi-Fi	External WiFi Doble(2.4GHz)	PC Viewer	Win7, 8, 10 (32Bit / 64Bit)
Application	Android 6.0, IOS 10.0		

PACKAGE CONTENTS



Front Camera



Rear Camera



Interior IR Camera



Windshield Mounts



Micro SD Card



Hardwiring Cable



Rear Camera Cable



3CH
Camera Cable



Y Cable(3CH)



Wi-Fi USB Dongle

LCD

Live Screen



Live Screen

- 1 Front camera(Cam-1)
- 2 Rear camera(Cam-2)
- 3 Exterior IR Camera(Cam-3)
- 4 Manual recording
- 5 Main menu

Live Screen PIP

Tap on the screen, switch to the front, rear recording and PIP.

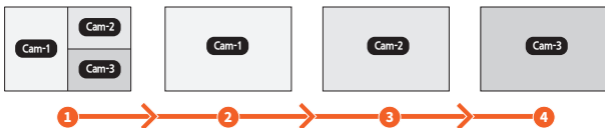

LCD



ADAS



Main Menu

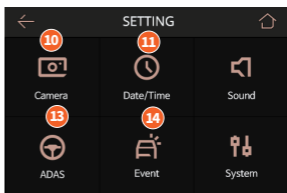

Setting

ADAS	1 ADAS(LDWS / FVDW / FCWS)
Main menu	3 Live view 4 Play back 5 Setting
Quick Menu	6 WiFi ON/OFF 7 Volume control 8 Voice Recording ON/OFF 9 Parking Recording ON/OFF
Setting	10 Camera setting 11 Time setting 12 Sound setting 13 ADAS setting 14 Event setting 15 System setting

LCD

Video Recording

If you go to the [Main Menu] and select [Play back], then choose the recorded video list and select the desired video file, the video will be played.

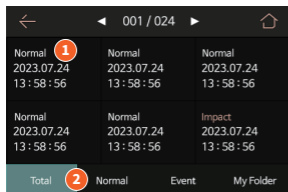

Recorded video list



Play recorded video

Recorded video list

1 Video recording list 2 Select recorded video type

Play recorded video

3 video play button 4 Front/rear/IR camera video switching

Memory

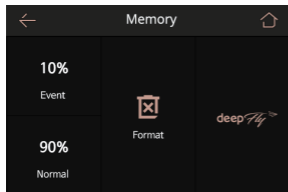

Manage storage memory ratio.

Secret Mode

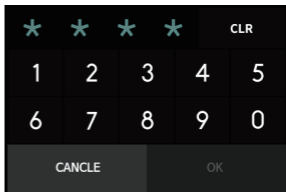

Using the secret mode function
You can protect recorded videos and prevent them from being deleted.

DEEPLY CONNECTED APP



Please download the DeepFly Connected app from the Play Store or App Store.



Google Play



App Store

Step 1. Enable the feature to WiFi

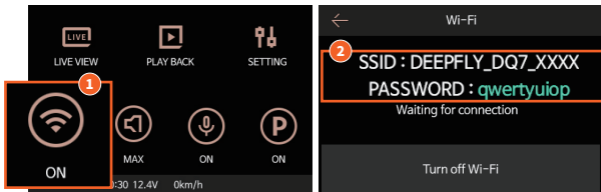

Press the WiFi button on the main menu screen of the dash cam to activate the WiFi feature.
Confirm the SSID and password.

Step 2. Connect smartphone

Select the SSID that starts with DEEPLY_DF30_XXXX from the smartphone's WiFi settings menu, enter the password, and connect to the device. (Password: qwertyuiop)

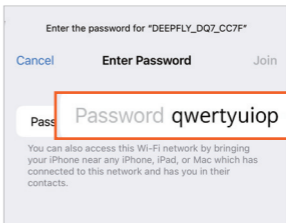
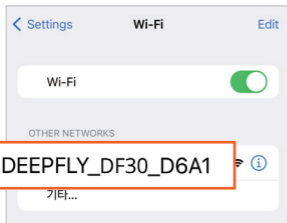

DEEPLY CONNECTED APP

① The app interface may vary slightly depending on the updated version.

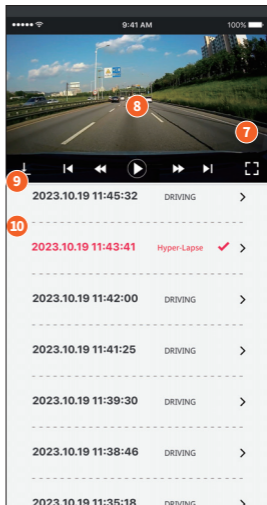
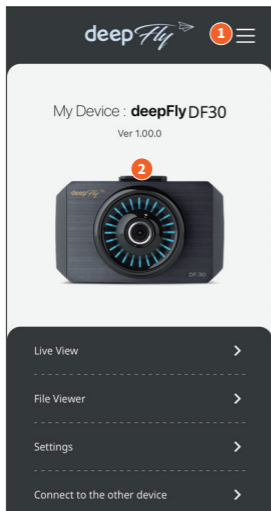

Home	① Menu ② My device ③ Live view ④ File viewer
	⑤ Setting ⑥ Connect to the other device
PLAYBACK	⑦ Camera selection (channel switching) ⑧ Recorded videos
	⑨ Playback bar (play, full screen, video download)
	⑩ List of recorded files

DEEPLY CONNECTED APP

 The app interface may vary slightly depending on the updated version.

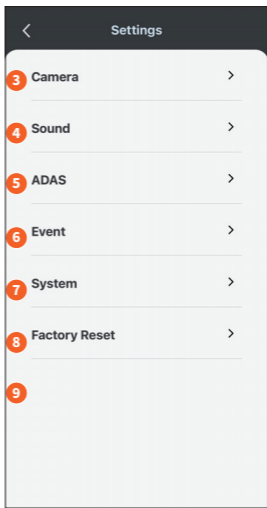
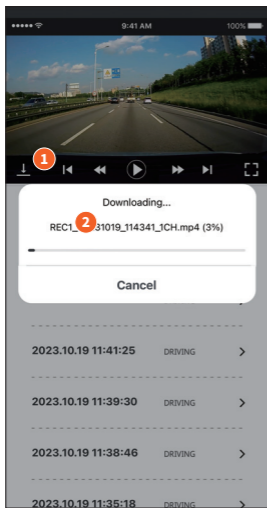

DOWNLOAD

1 Save video download icon **2** Download information

3 resolution/frame rate and other settings **4** Time settings

SETTING

5 Sound settings **6** ADAS settings **7** EVENT settings

8 System settings **9** Reset to default settings (factory reset)

Using the PC Viewer (Windows)

- The following provides brief information about the PC VIEWER screen layout.



- ① Front/rear video playback screen
- ② Video controller
- ③ Speed indicator
- ④ G-sensor information
- ⑤ Recording file list
- ⑥ Map
- ⑦ Full-screen
(Switch screens (Front / Rear))
- ⑧ Dashcam settings
Save the current video
- ⑨ Change language

Using the PC Viewer (MAC)

- The following provides brief information about the PC VIEWER screen layout.



① Front/rear video playback screen

② Video controller

③ Speed indicator

④ G-sensor information

⑤ Recording file list

⑥ Map

⑦ Full-screen
(Switch screens (Front / Rear))

⑧ Dashcam settings

⑨ Save the current video